



## WaveGuide Direction Explosion Proof

### User Manual



# WaveGuide Direction Explosion Proof User Manual

Version 5.2-1-1  
4<sup>th</sup> of Nov. 2020

Applicable for product no.  
WG5-DR-EX

Related to software versions:  
wdi 5.2-1



**Radac B.V.**  
Elektronicaweg 16b  
2628 XG Delft  
The Netherlands  
tel: +31(0)15 890 3203  
e-mail: [info@radac.nl](mailto:info@radac.nl)  
website: [www.radac.nl](http://www.radac.nl)



# Preface

This user manual and technical documentation is intended for engineers and technicians involved in the software and hardware setup of the WaveGuide 5 Direction, explosion proof version (WG5-DR-EX).

## Note

All connections to the instrument must be made with shielded cables with exception of the mains. The shielding must be grounded on both ends of the cable. For more information regarding wiring and cable specifications, please refer to Chapter 2.

## Legal aspects

The mechanical and electrical installation must be carried out by trained personnel with knowledge of the local requirements and regulations for installation of explosion-proof equipment in hazardous areas.

The information in this user manual is the copyright property of Radac BV.

Radac BV disclaims any responsibility for personal injury or damage to equipment or property caused by:

- Deviation from any of the prescribed procedures.
- Execution of activities that are not prescribed.
- Neglect of the general safety precautions for handling tools and use of electricity.

The contents, descriptions and specifications in this user manual are subject to change without notice. Radac BV accepts no responsibility for any errors that may appear in this user manual.

## Additional information

Please do not hesitate to contact Radac or its representative if you require additional information.



# Contents

## Preface

<b>Introduction</b>	<b>1</b>
<b>1 Safety and Security</b>	<b>3</b>
1.1 General	3
1.2 Safety Conventions	3
1.2.1 Warnings	3
1.2.2 Cautions	3
1.3 Safety Instructions	3
1.3.1 Safety	3
1.3.2 EC Declaration of Conformity (for EU)	5
1.3.3 Additional Information	5
1.4 Liability	5
1.5 Labels	6
1.6 Personal Safety	7
1.7 Warnings and Cautions	7
1.7.1 General	7
1.7.2 Tools	7
1.7.3 Working Environment	7
1.7.4 Required Skills	8
1.8 Electrical	8
1.8.1 Commissioning and Maintenance	8
1.8.2 Grounding	8
1.9 Accordance with Regulations	9
1.9.1 Explosion Safety	9
1.9.2 Compliance to RED	9
<b>2 Positioning and Installation</b>	<b>10</b>
2.1 Positioning	10
2.1.1 The point array	13
2.1.2 The line array	15
2.1.3 The triangle array	17
2.2 Instalation	18
2.2.1 Block diagram	18
2.2.2 WaveGuide processing unit	19
2.2.3 Cables	20
2.2.4 Glands	20
2.2.5 Housing	21
2.2.6 Wiring	21

2.2.7	Closing the housing . . . . .	23
<b>3</b>	<b>WaveGuide system commissioning</b>	<b>24</b>
	Step 1. Connect the WaveGuide processing unit to a computer . . . . .	25
	Step 2. Become an authorized user . . . . .	26
	Step 3. Configuration . . . . .	27
	Step 3.1: Set system date and time . . . . .	27
	Step 3.3: Sensor configuration . . . . .	29
	Step 4: Perform a system check . . . . .	32
	Step 4.1: Check the System Information page . . . . .	32
	Step 4.2: Check the reflection diagrams . . . . .	33
	Step 4.3: Check measurements . . . . .	34
	Step 5: Configure the distribution of data . . . . .	34
	Technical assistance . . . . .	37
<b>4</b>	<b>Using the system</b>	<b>38</b>
	4.1 Calculated parameters . . . . .	38
	4.2 Data logging . . . . .	38
	<b>Appendix 1: System parameters</b>	<b>40</b>
	<b>Appendix 2: System specifications</b>	<b>43</b>
	<b>Appendix 3: LED blinking modes</b>	<b>45</b>





# Introduction

The principle of operation of a WaveGuide 5 Direction system is based on the synchronized measurements of sea elevation (heave) at three different spots on the surface of the water. Using these measured elevations, the water surface slopes are calculated in two perpendicular horizontal directions. Then the correlations between the calculated slopes and the measured heave values are used to determine the wave directional information.

The WaveGuide processing unit supplied with the system takes care of the data handling (synchronizing and processing measurements as well as distributing and presenting data). The WaveGuide processing unit also facilitates commissioning and (remote) servicing of the system. All facilities are accessible via the built in web-server (running on the WaveGuide processing unit).

To perform the synchronized measurements, 3 sensors are included. In the WaveGuide 5 Direction Explosion Proof system the included sensors are WaveGuide 5 Water-Level Explosion Proof sensors. The sensors communicate their measurements to a WaveGuide Direction processing unit.

The WaveGuide sensors are low power X-band FMCW radars that measure the distance between the water surface and their antennas with an accuracy of  $< 1$  [cm].

The WaveGuide sensors are available in two versions:

- The Explosion proof version, where the electronics are build into an explosion proof housing.
- The Compact version, where the antenna and electronics are built into a compact stainless steel housing. The antenna and electronics are the same in both versions but the stainless steel version is easier to handle due to its compact size.

This manual describes the Explosion Proof version of the WaveGuide 5 Direction. Please refer to the radac website for all other manual versions.

## **Warning**

Do not use the instrument for anything else than its intended purpose.

This manual consists of 4 chapters. Chapter 1 specifies the criteria of sensor positioning for optimal quality of measurements. Chapter 2 illustrates the mounting and installation procedure. Chapter 3 describes the commissioning of the system via the user interface. Chapter 4 explains data processing, data presentation and data distribution within the system.

Please refer to Appendix 1: System parameters for a list of measured and calculated parameters. Refer to Appendix 2: System specifications for specifications, information about certification and environmental conditions applicable to the WaveGuide Direction. For information on the LED blinking modes please refer to Appendix 3: LED blinking modes.



# Chapter 1

## Safety and Security

### 1.1 General

For the correct and safe installing of this product, it is essential that all personnel follow generally accepted safety procedures in addition to the safety precautions specified in this document.

### 1.2 Safety Conventions

#### 1.2.1 Warnings

The following warning box is used within this document to urge attention in order **to prevent personal injuries** or dangerous situations.

**Warning**  
Carefully read the message in the warning boxes.

#### 1.2.2 Cautions

The following caution box is used within this document to urge attention in order **to prevent damages to the equipment**.

**Caution**  
Carefully read the message in the caution boxes.

### 1.3 Safety Instructions

The WaveGuide Directional system is a radar based level gauge for measuring water level and wave characteristics in offshore environments, lakes and rivers.

**Warning**  
Do not use the instrument for anything else than its intended purpose.

#### 1.3.1 Safety

The mechanical and electrical installation shall only be carried out by trained personnel with knowledge of the requirements for installation of explosion proof equipment in (potentially) an explosive atmosphere. The entire installation procedure shall be carried out in accordance with national, local and company regulations and standards.

**Warning - Risk of Explosion**

Use only Explosion proof (Ex d) compound cable glands or conduit seals, taking into account the local requirements, the local conditions, that the internal volume inside the sensor is larger than 2 [Liter] and that the sensor is classified as an Ex d IIB T6 Ga/Gb device.

**Warning - Risk of Explosion**

Cables and cable glands rated for use at at least 80 [°C] shall be used! Improper installation of cable glands, conduits or stopping plugs will invalidate the Ex approval of the WaveGuide. The use of stopping plugs on thread adapters is strongly advised against, as this may create unsafe Ex d characteristics.

**Warning - Risk of Explosion**

All lid bolts must be fastened with a torque of 30 [N·m] or 22 [lbf·ft] to prevent danger of explosion!

**Caution**

To comply with the IP66/IP67 requirements the blanking elements, threaded adapters, cable glands and their interface with the housing must also comply with IP66/IP67 requirements.

**Warning - Risk of Explosion**

To avoid risk of dangerous amounts of electrostatic charging, clean the instrument only with a damp cloth.

### 1.3.2 EC Declaration of Conformity (for EU)

See the EC declaration of conformity shipped with the device.

### 1.3.3 Additional Information

If you require additional information, contact Radac or one of its representatives.

## 1.4 Liability

The information in this installation guide is the copyright property of Radac BV, the Netherlands.

Radac BV disclaims any responsibility for personal injury or damage to equipment caused by:

- Deviation from any of the prescribed procedures.
- Execution of activities that are not prescribed.
- Neglect of the general safety precautions for handling tools and use of electricity.

The contents, descriptions and specifications in this installation guide are subject to change without notice. Radac BV accepts no responsibility for any errors that may appear in this user manual.

#### **Caution**

Modification to the instrument may only be carried out by trained personnel that are authorized by Radac BV. Failure to adhere to this will invalidate the warranty and the approval certificate.

## 1.5 Labels

Each processing unit and sensor carry a label indicating product type, model, serial number as well as product related specifications and certifications. Figures 1.1 and 1.2 illustrate examples of such labels.

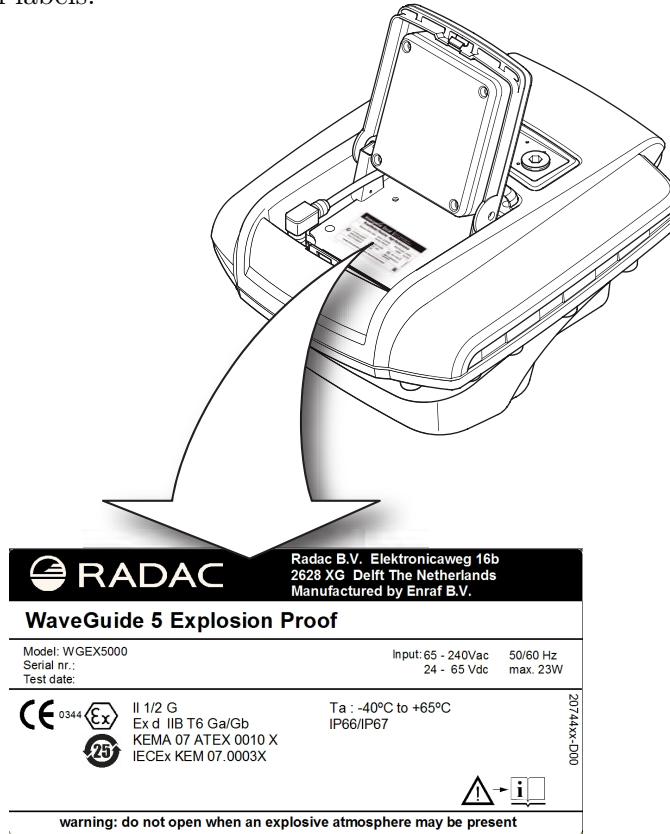

Figure 1.1: Example of WaveGuide 5 Explosion Proof sensor identification label.

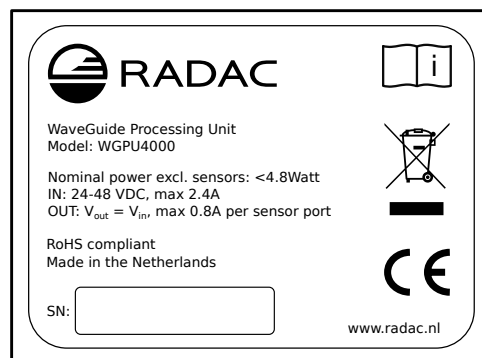

Figure 1.2: Example of WaveGuide 5 processing unit identification label located on the bottom side.

## 1.6 Personal Safety

### Warning

In hazardous areas it is compulsory to:

- Use personal protection and safety gear such as hard hat, fire-resistive overall, safety shoes, safety glasses and working gloves.
- Avoid possible generation of static electricity.
- Use non-sparking tools and explosion-proof testers.
- Make sure no dangerous quantities of combustible gas mixtures are present in the working area.
- Never start working before the work permit has been signed by all parties.

### Note

The emitted microwave energy is far below acceptable limits for exposure to the human body. A maximum radiation of  $0.1 \text{ [mW/cm}^2\text{]}$  per radar sensor is generated.

## 1.7 Warnings and Cautions

### 1.7.1 General

#### Warning

Make sure that all power to the instrument is switched off before opening the covers of the WaveGuide radar. Failure to do so may cause danger to persons or damage the equipment.

All covers of the WaveGuide radar must be closed before switching on the power.

### 1.7.2 Tools

#### Warning

Treat the flange surface of the cover and the housing with care. Keep the flange surface free of dirt. The O-ring must be present and undamaged.

#### Warning

Use non-sparking tools and explosion-proof testers. Use suitable explosion-proof tools (e.g. testing devices)!

### 1.7.3 Working Environment

#### Hazardous Zone

#### Warning

##### POTENTIAL ELECTROSTATIC CHARGING HAZARD

Avoid the generation of static electricity. Electrostatic charge/discharge of the device from/to a person or a tool could ignite a surrounding hazardous atmosphere.



## Safe Zone

### Warning

Make sure that no explosive gas mixtures build up in the working area.

### 1.7.4 Required Skills

### Warning

The technician must have technical skills to be able to safely install the equipment. The technician also must be trained to work in accordance with the national requirements for electrical equipment in hazardous areas.

## 1.8 Electrical

### 1.8.1 Commissioning and Maintenance

- The entire installation procedure must be carried out in accordance with national, local, and company regulations. The entire electrical installation shall be carried out in accordance with the national requirements for electrical equipment to be installed in hazardous areas.
- All wiring entries must be closed using the correct thread type such that the approvals are not invalidated. For installations using cable glands, use Ex d compound barrier glands. For installations using conduits, each conduit must be sealed within 18 inches of the enclosure.
- Improper installation of cable glands, conduits or stopping plugs invalidates the Ex approval of this device.
- Make sure that the housing of the device is properly bonded to the Protective Earth (PE).
- The temperature of the device's coupling due to local heat sources (e.g. contents of a tank or power dissipation) may not exceed a temperature of 80° [C].
- Cables and cable glands rated for at least 80° [C] (176° [F]) shall be used, unless ambient temperature is known to be always less than 50° [C] (122° [F]).

### 1.8.2 Grounding

### Warning

Make sure the housing of the device is properly connected to the ground reference! Make sure the electrical resistance of the ground connection is below the maximum prescribed by local requirements!

## **1.9 Accordance with Regulations**

### **1.9.1 Explosion Safety**

ATEX

II 1/2 G Ex d IIB T6 Ga/Gb or Ex d [ia Ga] IIB T6 Ga/Gb  
according to KEMA 07ATEX0010 X

IECEX

Ex d IIB T6 Ga/Gb or Ex d [ia Ga] IIB T6 Ga/Gb  
according to IECEX KEM 07.0003X

### **1.9.2 Compliance to RED**

This device complies with the Radio Equipment Directive. The device does not cause harmful interference and accepts any interference received. For more information please refer to the EC declaration of conformity shipped with the device.

# Chapter 2

## Positioning and Installation

### 2.1 Positioning

For obtaining the best results from each WaveGuide sensor, the following positioning criteria must be taken into account:

- It is advised to choose a mounting position such that the WaveGuide radar beam is free of large reflecting obstacles (the beam of the F08 antenna can be approximated to a conical shape having a  $5^\circ$  [deg] half top angle as shown in Fig. 2.1). The minimum horizontal distance between a sensor and any obstacle in the beam's path should be at least 10% of the vertical distance between the sensor and the obstacle. This does not only include horizontal objects in the beam's path but also vertical structures.
- Any structure that the WaveGuide sensors are mounted to might have some influence on the waves progressing around it. Hence, it is advised to mount the sensors at a position facing the mean wave direction so that they can measure the least disturbed water surface.
- The minimum measuring distance is at 2 meter. As such, the sensor should be mounted with its reference point at least 2 meter above the highest expected waterlevel during the period in which the water surface is monitored. The reference level for the mounting height of the radars is shown in Fig. 2.1.
- Figure 2.2, shows the polarization plane of the signal emitted from the radar antenna. If the WaveGuide radar is mounted close to a large vertical wall, then the radar should be mounted such that the polarization plane is parallel to the wall. That is to minimize the effect of the wall on the propagation of the signal. Nevertheless, the horizontal distance between the radar and the wall should comply with the previous criteria.
- A vertically mounted radar ( $0^\circ$  [deg] tilt angle) results in optimal performance. But if necessary the WaveGuide sensor can be mounted with a maximum tilt angle of  $15^\circ$  [deg] (tilted to face the direction away from the structure it is mounted to).

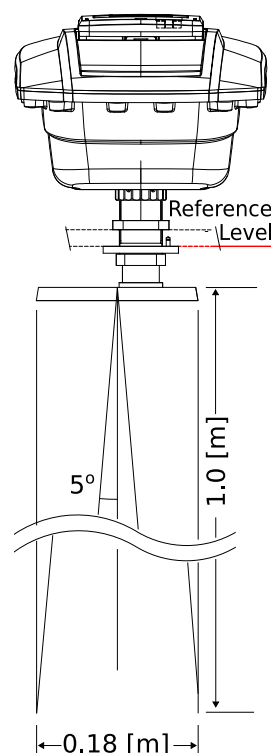

Figure 2.1: The  $5^\circ$  [deg] half top angle of the F08 antenna beam and the reference level for mounting height measurement.

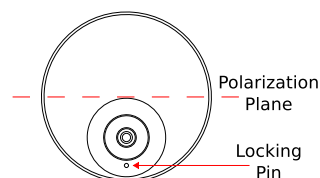

Figure 2.2: Top view of radar antenna and its polarization plane.

The working principle of the WaveGuide Direction is based on the measurement of surface elevation at three different positions, using an array consisting of three radars. The array design criteria are:

- The footprints (measurement points) of the three radars on the sea surface must form a triangle.
- To obtain directional information of the same quality for all wave directions an equilateral triangle is preferable but not critical.
- The measurement of wave directional parameters is optimal for wave lengths that are more than 3 times the array size (distance between the center of two radar footprints). For example, if the dominant wave periods are between 3 and 10 [sec] long (wave lengths from 15 to 150 [m] long). Then for such waves, a configuration allowing 5 [m] between radar foot-prints would be optimal.
- For the optimal setup, it is recommended to mount the Radar A sensor in a vertical position.

To allow the WaveGuide Direction to be installed in various locations it is designed to be mounted in one of three array configurations. All three configurations allow for the radar array footprint to form an equilateral triangle on the sea surface at mean water level.

- The point array is the recommended configuration in most situations. Here the three radars are mounted on a single frame. One radar is looking vertically downwards. The other two radars are tilted with an angle of 15 [deg] from the vertical in the direction away from the downward looking radar. In this case the size and position of the array footprints depend on the choice of tilt angle and the vertical position of the radars (height above actual water level).
- The line array, where the mounting positions of the three radars form a straight line. The two outside radars are mounted at zero inclination angles and the middle radar is tilted with an angle between 10 and 15 [deg] in a direction perpendicular to the line the radars are mounted on. In this case the size and position of the array footprints depend on the mounting position, the tilt angle and the vertical position of the radars (height above actual water level).
- The triangle array, where the mounting positions of the three radars form a triangle and all three radars are mounted at a zero inclination angle (resulting in optimal performance). In this case the size and orientation of the array footprints are determined only by the horizontal positions of the radars.

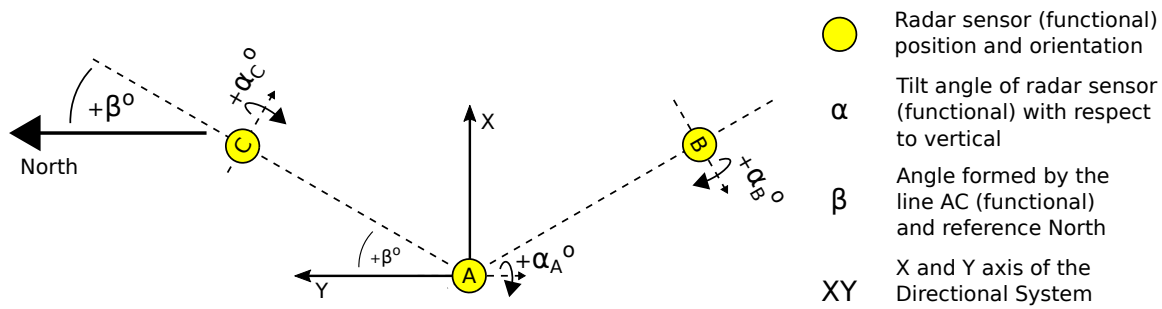

Figure 2.3: Definitions for WaveGuide Direction systems.

The proper installation of a WaveGuide Direction array of radars requires understanding the following naming conventions and standards:

- Each of the three radars, defined by its serial number, is given a functional name (A, B or C). If necessary it is possible to adjust these relations through the user interface.
- By definition, radar B will always be positioned on the right side of the line A-C, or in the case of a line array on the line A-C.
- The positions of radars A and C define the array orientation with respect to the reference North.
- When specifying a tilt angle for radar B and C, the tilting direction will be aligned with the position of radar A and the tilt angle will be positive when tilting away from A. (Right hand rule in Fig. 2.3.)
- When specifying a tilt angle for radar A the tilting direction will be aligned with the center between positions B and C and positive in the direction of the center between B and C. (Right hand rule in Fig. 2.3.)
- On the "Configuration -> Sensor" page of the web-interface the following parameters can be found (more information about accessing and using the web-interface is available in Chapter 3):
  - Distances between radars A, B and C.
  - The angle from the reference North to A to C.
  - Relation between the radar A, B and C (functional) and the physical radars defined by their serial number.
  - The configuration parameters and reflection diagrams of the selected radar.

### 2.1.1 The point array

The point array has proven to be an easy to install configuration that requires the smallest amount of space on the supporting structure. The correct installation requires the radars to be installed in a counter clockwise manner with radar A installed vertically and B and C at a fixed tilt angle.

Upon request, Radac can provide a standard mounting frame (product no. WG5-MDP-EX) that allows for easy and accurate mounting of the system (Fig. 2.5 ). The mounting frame can be used to mount the three radars together while allowing the vertical mounting of one radar and the tilted mounting of two radars (tilted to 15 [deg] from vertical). This results in an array footprint size that is approximately 25% of the mounting height. Using the array design criteria it can be concluded that this configuration is optimized for measuring directional wave parameters for wave lengths that are 0.75 to 7.5 times the mounting height. For example, a mounting height of 10 [m] is optimal for wave lengths in the range from 7.5 to 75 [m] (wave periods from 2.2 to 7 [sec]). While a mounting height of 25 [m] is optimal for a wave length range from 18.75 to 187.5 [m] (wave periods from 3.5 to 11 [sec]).

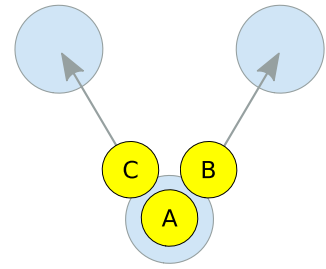

Figure 2.4: Top view of the three radar positions labeled A,B and C in an anticlockwise sequence. In this case the labels apply to the physical radars and their functional definitions.

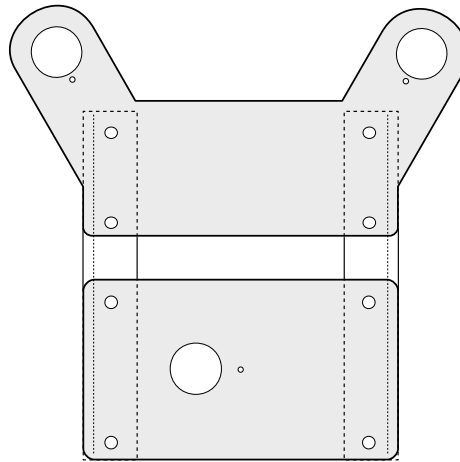

Figure 2.5: Simplified top view of a point array mounting frame (product no. WG5-MDP-EX).

The optional point array mounting frame (product no. WG5-MDP-EX) consists of two parts as shown in figure 2.5. The mounting frame should be installed on two horizontal beams (the horizontal beams are not included in the mounting frame package). Note: when designing and producing the horizontal mounting beams, enough horizontal distance should be left between the radars and the structure they are mounted to. That is, to prevent reflections (as explained in the beginning of this chapter). If the customer chooses to design and manufacture a frame, the centers of the mounted radar sensors must form an equilateral triangle. When installing the radar array it is advised to first install the mounting frame, and secondly position the three radars.

Radar sensor	A	B	C
Tilt angle [deg]	0	15	15
Min. Signal [dB]	25	25	25

Table 2.1: Advised sensor settings specific to a point array.

### 2.1.2 The line array

In some cases it can be decided to mount the three radars in line with each other, for example when mounting them to the railing of an offshore platform. This installation is called a line array. In this case the central radar needs to be tilted to obtain a triangular reflection footprint, which is illustrated in Fig. 2.6. In a line array, the tilting definitions (Fig. 2.3) require that radar A is positioned between radar B and C. This allows tilting radar A away from the line B-C and by doing so forming a triangle with the radar foot prints on the water surface. The direction of the radar tilt angle is defined with the right hand rule as shown in Fig. 2.6. It is advised to select non-tilted radar B or C as the "heave source", which is the source of data for calculating the non-directional wave parameters.

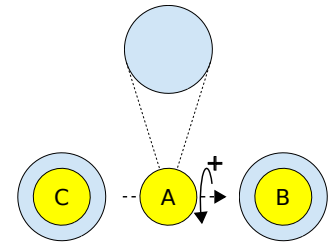

Figure 2.6: Top view of the three radars labeled A, B and C.

A mounting plate can be used to fix each radar to two horizontal beams at the desired location (an example sketch of such a plate is given in Fig. 2.7). Upon request, Radac can supply such a mounting plate (product no. WG5-MP-EX). During installation it is advised to install the mounting plate first and secondly install the radar.

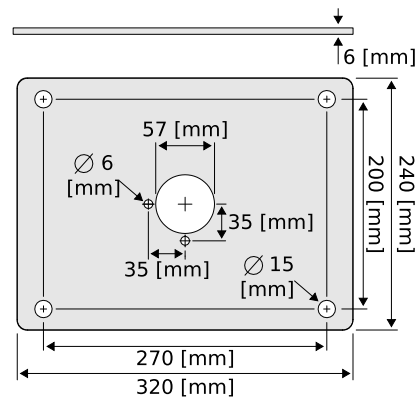

Figure 2.7: Optional mounting plate for the WaveGuide radar (Part no. WG-MP-EX).

Radac can provide an optional dual-purpose wrench/spanner (Part no. WG-EX-tool). One end of the wrench (Fig. 2.8) is an open-end wrench that can be used to tighten the antenna to the mounting plate, while the other end is a pin wrench that can be used for tightening the radar housing to the antenna.

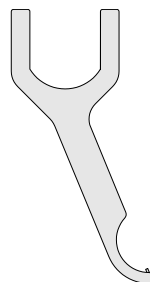

Figure 2.8: Optional wrench that allows mounting of the WaveGuide radar (Part no. WG-EX-tool).



Upon request, Radac can supply an optional frame (product no. WG-MH-EX) that allows for mounting a radar at angles 0, 5, 10, 15 and 20 [deg] with the horizontal plane shown in Fig. 2.9). Each frame includes the mounting plate shown in Fig. 2.7 as well as brackets to allow mounting the frame to a handrail.

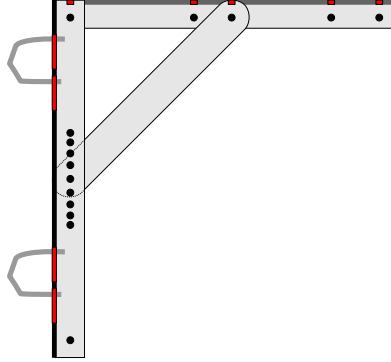

Figure 2.9: Optional frame that allows mounting of the radar at different angles (product no. WG-MH-EX).

Radar sensor	A	B	C
Tilt angle [deg]	15	0	0
Min. Signal [dB]	25	25	25

Table 2.2: Advised sensor settings specific to a line array.

### 2.1.3 The triangle array

The triangle array consists of three radars placed with no any tilt angle, typically about 3 to 6 meter apart. It can be challenging to find a good mounting position for the triangle array on an offshore platform. On the other hand, from the perspective of retrieving the strongest radar reflections, this is the optimal configuration for large mounting heights (above 45m).

Radars A, B and C are defined by their serial number as indicated on the type plate. The mounting positions of radars A, B and C must be anticlockwise when looking from above (as shown in Fig.2.10). The user-interface allows the user to customise the used configuration.

A mounting plate can be used to fix each radar to two horizontal beams at the desired location (an example sketch of such a plate is given in Fig. 2.11). Upon request, Radac can supply this mounting plate (product no. WG-MP-EX). During installation it is advised to install the mounting plates first and secondly install the radars.

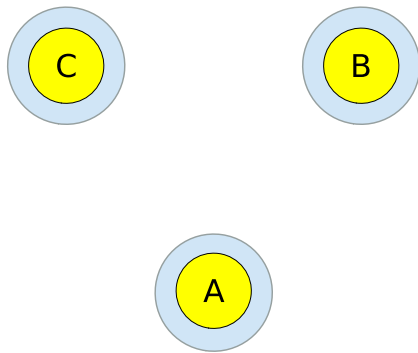

Figure 2.10: The three radar positions are numbered A,B and C in an anticlockwise sequence.

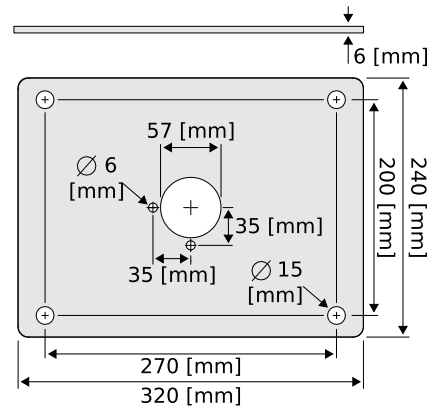

Figure 2.11: Optional mounting plate (product no. WG-MP-EX) for the WaveGuide 5 Compact Radar.

Radar sensor	A	B	C
Tilt angle [deg]	0	0	0
Min. Signal [dB]	25	25	25

Table 2.3: Advised sensor settings specific to a triangle array.

## 2.2 Instalation

### 2.2.1 Block diagram

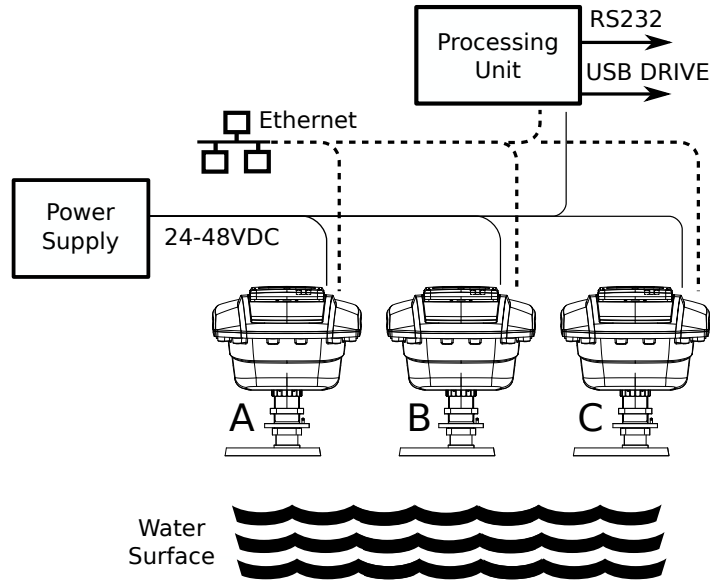

Figure 2.12: Block diagram of the Waveguide 5 Direction. The three sensors A, B and C are connected to the local network as well as the processing unit. This diagram assumes the processing unit and the radars to be powered by a single power supply.

For the system to function, the three radars and the processing unit must be powered and connected to a local network. The processing unit provides the option to export data over Ethernet or two RS232 serial ports and allows the use of a USB drive for storing data. Additionally each of the radars has an internal data storage.

Depending on the installation location a junction box with a network switch can be used to reduce the length of required cable.

The following sections explain the detailed connection of the radars and the processing unit.

## 2.2.2 WaveGuide processing unit

### Note

The RS485 connectors labeled as Sensor 1, Sensor 2 and Sensor 3 should not be used.

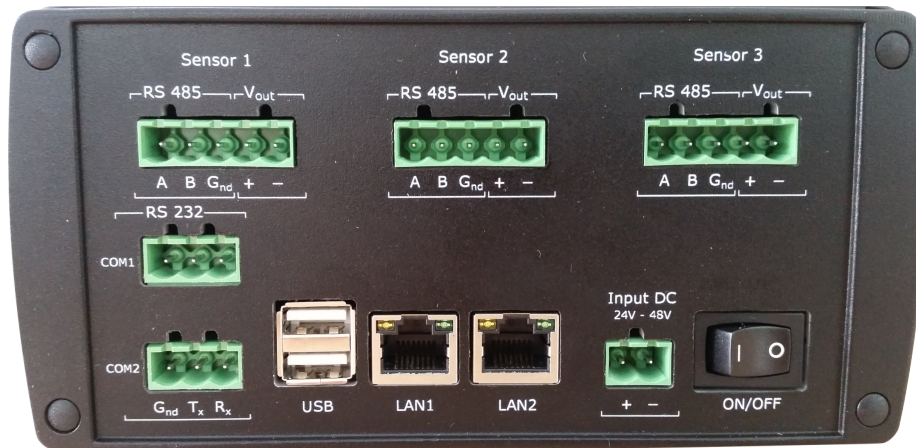

Figure 2.13: Connector panel on the WaveGuide processing unit.

The connector panel of the WaveGuide processing unit includes the following functional connectors:

- COM1: Serial port for RS-232 data output.
- COM2: Serial port for RS-232 data output.
- USB: For connecting a USB data storage.
- LAN ports: Ethernet access to the processing unit.
- Input DC: For supplying the processing unit with 24V to 48V power.
- Sensor 1, 2 and 3: Not in use.

### 2.2.3 Cables

When selecting a cable for use with a WaveGuide system, the following specifications must be used:

- Two wires for power transmission, the choice of power supply will influence the diameter and insulation thickness of those wires.
- Four wires for data transmission, at least satisfying Category 5e Ethernet cable (Cat 5e) specifications.
- The cable must be shielded and can have a maximum length of 80 [m].

Upon request, Radac can supply an optional cable that complies with the WaveGuide system requirements for power and data transmission.

#### Note

All connections to the instrument must be made with shielded cables with exception of the power supply. The shielding must be grounded on both ends of the cable.

### 2.2.4 Glands

Depending on local regulations, this device can be connected by using glands, direct entry, or conduits

An explosion proof (Ex-d) compound cable gland (M20), plus a M20 to 3/4" NPT converter are supplied with each WaveGuide radar for use as a safe and watertight cable entry point. The supplied gland allows the installation of cables from 6.5 to 11.9 [mm] in diameter.

Two approved 3/4" stopping plugs are provided for sealing the unused cable inlets

#### Note

Instructions supplied by the manufacturer for installing the included cable gland are provided separately in its packaging.

#### Caution

The use of Ex-d certified materials of an inappropriate IP value or the improper installation of cable glands, conduits or stopping plugs will invalidate the Ex approval of the WaveGuide.

## 2.2.5 Housing

To access the WaveGuide radar case:

- Open cover A as shown in Fig.2.14.
- Open and remove cover B as shown in Fig.2.15.
- Use an 8 [mm] Allen key to loosen the 16 bolts of the housing. Make sure the 4 bolts on the side of the hinge are entirely screwed into the cover and do not protrude beyond the flange of the housing. Otherwise the flange of the housing can be damaged when closing the cover.
- Open the housing cover.

## 2.2.6 Wiring

The housing contains two sets of DIN rail connectors as well as multiple ground connection points.

Figure 2.16 shows the DIN rail connector set and the sequence of relevant poles. The poles number 00 labeled PSX:Vin-a/L and 01 labeled PSX:Vin-b/N are used to supply the system with either 24-65 [VDC] or 65-240 [VAC] power. The internal power supply is reverse polarity protected hence the polarity of the connected wires does not matter.

Please do take into account the voltage drop due to wire resistance between the power supply unit and the radar, the radar must at all times receive more than 21.0 [VDC]. For this reason, to be sure to stay within the limits, at longer distances it is advised to use a 36 [VDC] or a 48 [VDC] power supply.

The poles numbered 02, 03, 04 and 05 labeled RFL:Tx+, RFL:Tx-, RFL:Rx+ and RFL:Rx- relate to Ethernet data RJ45 pins 1, 2, 3 and 6.

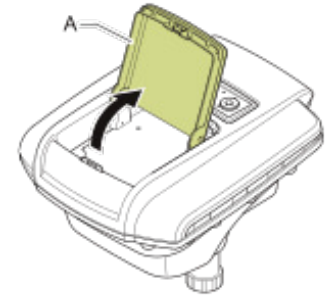

Figure 2.14: Cover A.

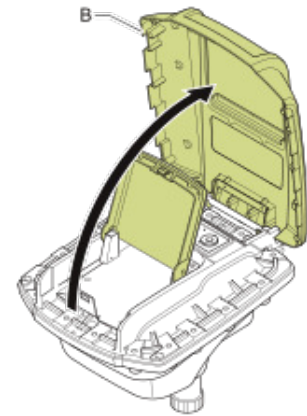

Figure 2.15: Cover B.

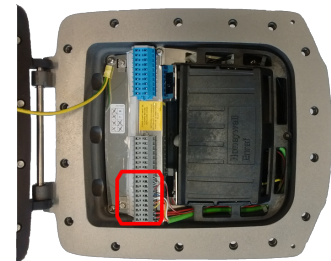

Figure 2.16: Terminal compartment and connections.

Label	RJ45	Profinet Color
Tx+	1	Yellow
Tx-	2	Orange
Rx+	3	White
Rx-	6	Blue

Table 2.1: Ethernet wiring instruction.

The poles numbered 06 and 07 labeled RFL:LED+ and RFL:LED- are pre-connected to a status indicating LED. Upon powering the system the status LED will turn on and continue to shine while the system is starting up. When the startup process is completed and the system is running in normal mode the LED will blink every 4 [sec] ( 2 seconds on and 2 seconds off). In the case that a network connection can't be detected, the LED will blink every 1 [sec] ( 0.5 seconds on and 0.5 seconds off).

Additionally a reset function is implemented on poles 08 and 09 that are both labeled RFL:Reset, which should only be temporarily connected when resetting the radar to its factory settings or setting a fixed IPV4 address.

#### Note

Connecting the Reset poles for for 0.5 to 2 seconds during operation will cause the sensor to temporarily use the default IPV4 address 192.168.111.71 until the system is rebooted.

Connecting the Reset poles for longer than 10 seconds during operation will cause the sensor to reset to default factory settings and reboot. The indicator LED will flash rapidly during this procedure. Refer to Appendix 3: LED blinking modes for a description of the LED blinking modes.

The cable shielding must be connected to ground at both ends of the cable. Since there can be a potential difference between the ground at the radar and the ground at the processing unit, a capacitor (10 to 100 [nF]) should be used on one side of the cable between its shield and the ground.

#### Warning

Improper wiring can damage the radar's communication board. Always check that power is applied to the right connector before connecting it!

#### Warning

Make sure the housing of the device is properly connected to the ground reference! Make sure the electrical resistance of the ground connection is below the maximum prescribed by local requirements!

Upon powering the system the status LED will turn on and continue to shine while the system is starting up. When the startup process is completed and the system is running in normal mode, the LED will blink twice for half a second after which it will remain off for 4

seconds. Any other blinking mode will warn you that the system is not functioning in its normal mode of operation. See Appendix 3: LED blinking modes for a description of the different LED blinking modes.

### **2.2.7 Closing the housing**

Make sure that the flange is clean, that the O-ring is in place and not damaged. Then:

- Make sure to properly close the lid.
- Use an 8 [mm] Allen key to tighten the 16 bolts of the housing to a torque of 30 [N·m] or 22 [lbf·ft].
- Open the small cover (cover-A).
- Place the 2 hooks at one end of cover-B behind the axis on the housing and push it down carefully.
- Push down cover-A carefully.



# Chapter 3

## WaveGuide system commissioning

With all system components correctly connected as described in the previous chapter, the processing unit can be configured using the following steps (explained in the current chapter):

1. Connect the WaveGuide processing unit to a computer.
2. Become an authorized user.
3. Configure the system.
4. Perform a system check.
5. Configure the distribution of data.

The display on the processing unit shows system information and measured parameters and is controlled using the buttons on the front:

- Left and right: To switch between groups.
- Up and down: To switch between items within each group.
- OK: To confirm mounting and unmounting of USB data storage.

The processing unit display contains the following groups and items:

- Parameters
  - Scrolls through selected parameters (Appendix 1: System parameters)
- Network
  - Host name
  - IP address
- System information
  - Date and time
  - Uptime
  - Software version
- USB storage (only appears when USB device is connected)
  - State
  - Mount USB disk?/ Unmount USB disk?

## Step 1. Connect the WaveGuide processing unit to a computer

Once the WaveGuide system is connected to a Local-Area-Network, communication can be done via the available web interface (Fig. 3.1). For this purpose any web browser with JavaScript enabled can be used.

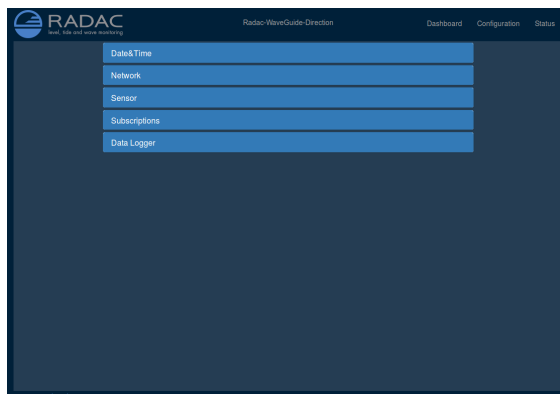

Figure 3.1: The web-interface of the WaveGuide processing unit.

### Note

A computer can be connected to the WaveGuide processing unit directly using a network cable (a crossover cable is not required).

By default, the WaveGuide processing unit tries to obtain an IPv4-address by searching the Local-Area-Network for a DHCP server. When required the user can also setup the system to always use a defined static IPv4 address.

When the WaveGuide processing unit completes the startup process, its IP-address can be found via the LCD display (it can take up to 5 minutes for the IP-address to appear). To view the IP-address, scroll through the menu using the left and right buttons until network information is displayed and then use the up and down buttons to switch between displaying the Host-Name and the IP-address.

An other way of locating the system in a network is by making use of the installed Zeroconf client. Using a Zeroconf browser makes it easy to find the processing unit and the connected radars.

To access the web-interface, type the IP-address indicated on the LCD display in the address line of your web-browser (e.g. 192.168.111.71).

### Note

That in order to access the user interface both the computer and the WaveGuide processing unit must be on the same IPV4 address subnet.

The WaveGuide processing unit homepage contains three main sections (Dashboard, Configuration and Status) as listed in Table 3.1.

Link	Description
Dashboard	Visualisation of the measured data.
Configuration	Changing the settings and configuration of the system.
Status	System state overview and general information.

Table 3.1: Description of the WaveGuide system main sections.

## Step 2. Become an authorized user

To modify the WaveGuide system’s configuration you need to be an authorized user. Therefore, an authorization dialogue will appear when the user enters the configuration page.

The authorization will be valid for a duration of 30 minutes. However, the web browser may store the login name and password. In that case, the authorization data will be submitted automatically by the browser without a pop-up dialog. The default login password is “radac”.

After a successful authorization, the user can view and change settings. After submitting any new settings a reboot dialog will appear. To ensure proper initialization of the new settings, the WaveGuide system must be rebooted.

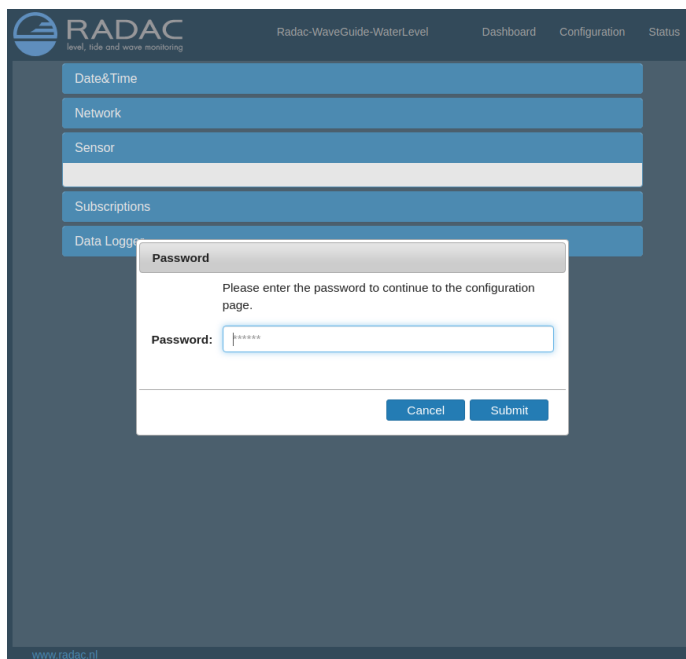

Figure 3.2: Login window.

### Step 3. Configuration

The configuration page contains five sections as listed in Table 3.1.

Link	Description
Date&Time	For viewing and setting the system time.
Network	For viewing and changing the network settings.
Sensor	For viewing and changing the sensor specific settings and for viewing reflection diagrams.
Subscriptions	To set up data export over the serial ports or over the network.
Data Logger	To log data on a USB drive.

Table 3.1: Description of configuration page sections.

#### Step 3.1: Set system date and time

In order to ensure an accurate timestamping of the data, the WaveGuide system runs an NTP time service to automatically correct its system time to UTC time. For the NTP service to work, the system needs to be connected to the Internet, as it needs to be able to reach its default NTP servers.

In the case that the NTP servers can not be reached, it is possible to manually set the system date and time using the "Date&Time" menu (Fig. 3.3). Adjusting the date and time while the NTP service is running is not possible as the time will be automatically corrected back to UTC time. The date and time are kept by an on-board clock. Please be aware that such on-board clocks are not highly accurate and can drift over the years while the system is used; it is thus advised to use the NTP service.

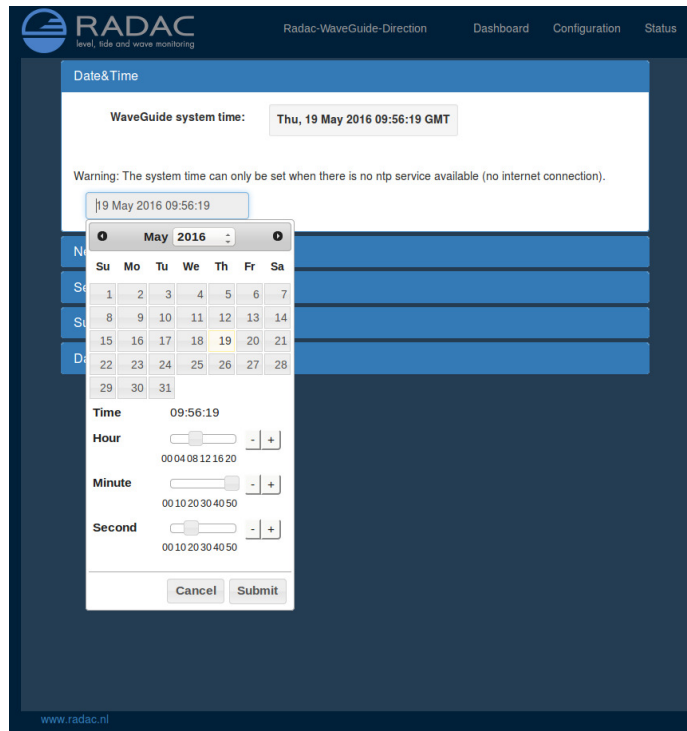

Figure 3.3: Setting the system time and date.

If the WaveGuide system is not connected to the Internet but instead connected to a local network that includes a time server, then the system can be adjusted to synchronize time and date with the local time server using the "Set NTP" button and submitting the local NTP server address.

### Step 3.2: Adjust network settings



Figure 3.4: Adjusting the network settings.

The network settings can be modified via the web-interface (Fig. 3.4). It is advised to use the default setting, to automatically obtain the network settings from a DHCP server, and assure from the side of the DHCP server that the system will receive the same IP-address at all times. This setting provides the easiest setup and ensures the correct settings for the local network.

#### Note

To ensure an accurate system time, the WaveGuide system is by default configured to use an NTP time service. For this service to work, a connection to the Internet is necessary.

#### Note

Configuring the use of a static IP could disable the NTP service when the system is not able to reach any nameserver. The user interface allows to manually add or remove nameserver addresses.

### Step 3.3: Sensor configuration



Figure 3.5: Sensor configuration menu.

The WaveGuide Direction is designed with a high level of flexibility in mind, to apply to every possible mounting situation. The sensor menu allows the configuration of those parameters that are specific to the sensor installation (Fig. 3.5).

During the installation process it is important to register the position of each of the three sensors. The identity of each sensor is defined by its serial number which is shown on the type plate.

In the box labelled as "Distance [cm]" fill in the distances between the radar reference points (see Fig. 2.1 for the radar reference point). Next fill in the "Orientation [deg]", defined by the angle from the vector pointing to the North to the line A-C (from radar A to radar C). The "preview geometry" field to the right, automatically generates an illustration in top-view of the array configuration. The geometry preview includes the approximated radar reflection footprints based on the parameters provided (see Fig. 3.6).

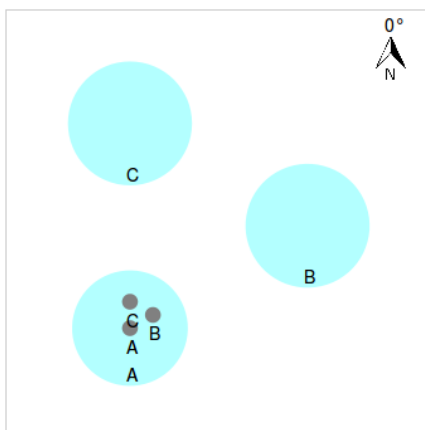

Figure 3.6: Preview of the array orientation based on user input.

The mounting height above the reference water level, and possibly a number of other parameters, needs to be set for each specific mounting location. This can be done in the configuration table that is shown in Fig. 3.7.

Radarsensor	A	B	C
Radarserial nr. 	C500159	C5000224	C5000193
Mounting height [m]	10	10	10
Tilt angle [deg]	0	15	15
Max. Range [m]	75	75	75
Min. Range [m]	2	2	2
Min. Signal [dB]	25	25	25
Heave Source	<input checked="" type="radio"/>	<input type="radio"/>	<input type="radio"/>
Reflection diagrams	<input type="button" value="Plot"/>	<input type="button" value="Plot"/>	<input type="button" value="Plot"/>

Figure 3.7: Setting sensor parameters (changes only take effect after the system is rebooted).

### Radarserial nr.

The first item in the table, the radar serial number, allows modification of which sensor shall serve as sensor A, B or C.

### Mounting height

The mounting height is defined as the height of a radar above the reference water level in [m]. The reference point for measuring the height of each radar is the lower-side of the radar mounting flange (as shown in Fig. 2.1). By default, the mounting height is set to zero [m].

### Tilt angle

The tilt angle, or the angular deviation from the vertical at which the radar is mounted, is measured in degrees. For the point array, it is used to tilt radars B and C away from radar A and obtain a favorable radar-footprint-triangle. In the triangle array, all 3 radars have a tilt angle of 0 [deg]. While for the line array, only radar A will need to have a tilt angle

applied (as explained in Chapter 1).

### **Max. Range**

The range maximum in [m] is the maximum distance at which the sensor will detect the water level. In general there is no need to modify this parameter. Yet in some situations it is advised to set this parameter to a value lower than two times the distance from the radar to the lowest expected water level. This is to avoid detecting multiple echoes of the same measurement sweep.

### **Min. Range**

The range minimum in [m] is the minimum distance at which the sensor will detect the water level. This parameter is used to avoid spurious measurements and should be set depending on the installation location. If there are any nearby surfaces that can reflect the radar signal the range minimum should be set to a value higher than the distance to those reflecting surfaces. The range minimum parameter should not be lower than 2 [m] to avoid interference with the internal reflection in the radar antenna.

### **Min. Signal**

The signal minimum is the lower limit for the signal power that will be considered in water level measurements. This parameter is by default set to 25 [dB], and should only be adjusted by an expert user.

### **Heave Source**

With three radars available it is possible to select one of the three radars to supply its data to the algorithm for calculating all non-directional parameters (i.e. wave height and period). The radar that is used for measuring non directional parameters is called the 'Heave Source'.

### **Reflection diagram**

The reflection diagram gives a snapshot of raw radar data in the frequency domain. The reflection diagram provides a useful insight in the quality of the reflection signal that is obtained by the radar.

After changing the sensor parameters for the three sensors by pressing the submit button, rebooting the system is required for the changes to take effect. The reflection diagram of each sensor should be checked to ensure that the water level measurement is within the defined limits (More information can be found in 'Step 4.2: Check the Reflection Diagrams').



## Step 4. Perform a system check

This section explains how to inspect the quality of measurements after configuring and rebooting the WaveGuide processing unit (the start-up process can take up to 5 minutes):

### Step 4.1: Check the system information page

The system information table can be reached through the status menu item on the right top. The system info page displays the communication status (as shown in Fig. 3.8). A communication status "INIT" indicates that the WaveGuide processing unit is initiating the communication process with the radar sensors. Once the communication process is initiated (a process that can take up to five minutes after reboot) the displayed status becomes 'OK'.

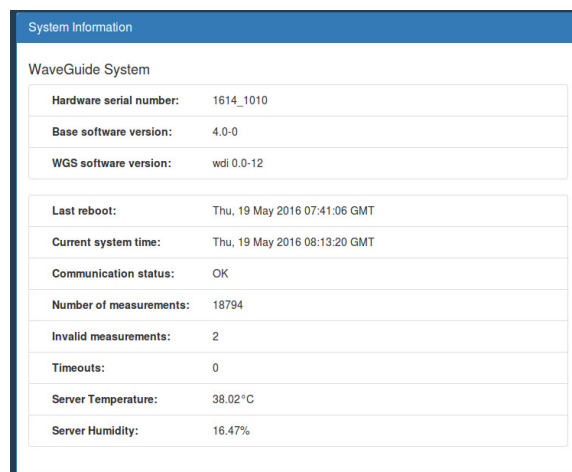

System Information	
WaveGuide System	
Hardware serial number:	1614_1010
Base software version:	4.0-0
WGS software version:	wdi 0.0-12
Last reboot:	Thu, 19 May 2016 07:41:06 GMT
Current system time:	Thu, 19 May 2016 08:13:20 GMT
Communication status:	OK
Number of measurements:	18794
Invalid measurements:	2
Timeouts:	0
Server Temperature:	38.02°C
Server Humidity:	16.47%

Figure 3.8: System information.

In the same table, the ratio between the number of performed and invalid measurements gives an indication of the system performance. When the system is set up in a correct manner, the number of invalid measurements should be below 10% of the number of performed measurements.

#### Step 4.2: Check the reflection diagrams

The reflection diagram for each sensor can be accessed via the sensor configuration page by clicking on the corresponding "reflection" button (Fig. 3.9).

A reflection diagram is a graphic representation of a 25 [ms] scan, where the signal strength [dB] is plotted against the measurement distance [m]. A scan consists of one up-sweep (increasing frequency, blue curve) and one down-sweep (decreasing frequency, red curve).

Often several peaks are visible in a reflection diagram as shown in Fig. 3.9. This is caused by the multiple signal reflections between radar, water surface and any objects within the radar foot-print. The leftmost peak is generated by the so called internal reflection. The signal processing takes this phenomenon into account such that it does not have a negative effect on the measurements.

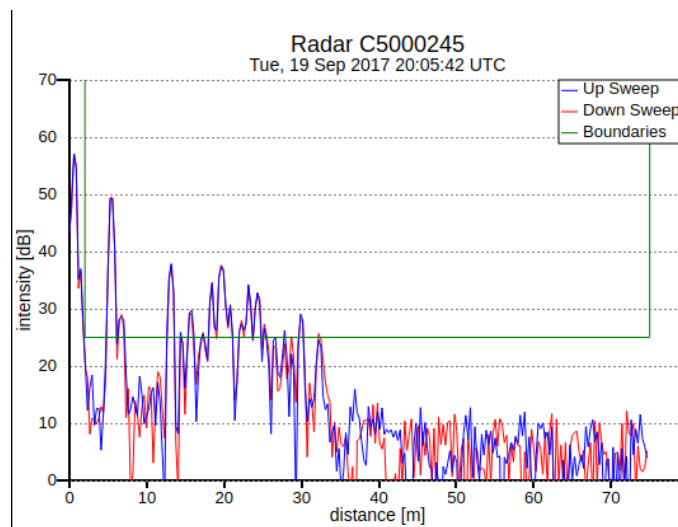

Figure 3.9: The reflection diagram of one of the three sensors.

Based on the defined range maximum and minimum values, the WaveGuide system shows the applied boundaries using vertical green lines. A horizontal green line shows the minimum accepted reflection strength (the value set as the Signal Minimum [dB] parameter). The three green lines together form a region in which a measurement is accepted, and any result outside of it is ignored.

### Step 4.3: Check the measurements

On the 'Dashboard' page, the heave parameter shows data measured during the last 1, 3 or 10 minutes. Please inspect the available heave and slope graphs to visually confirm the measured data. From the same menu all calculated parameters are available. Please take into account that it can take up to 10 minutes to gather enough raw data to calculate the parameters.

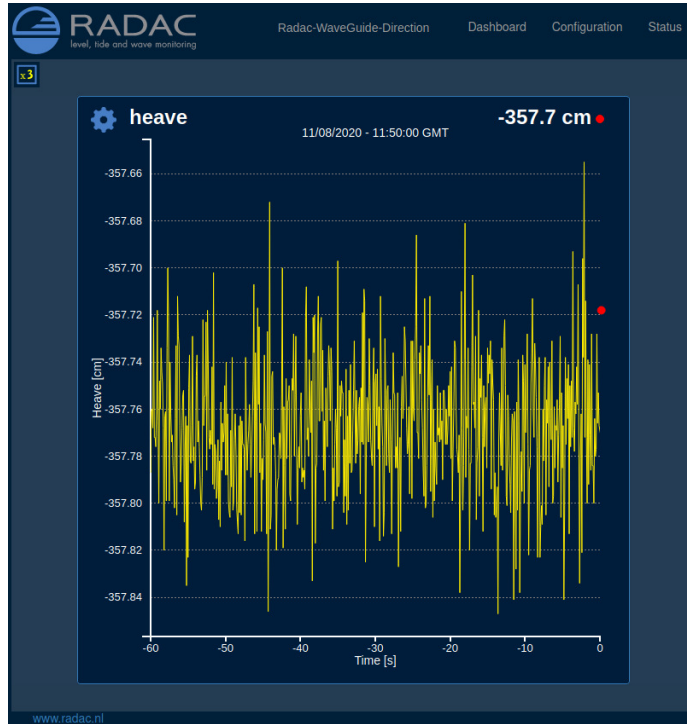
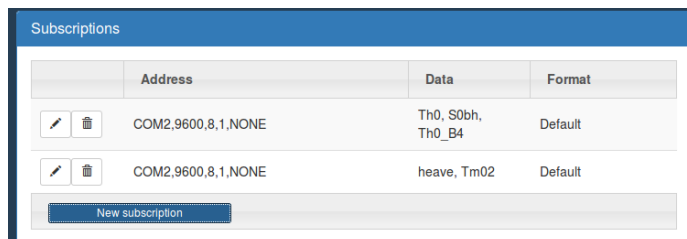

Figure 3.10: Dashboard view.

### Step 5. Configure the distribution of data

The WaveGuide processing unit can transmit measured and calculated data via its serial ports (COM1 & COM2) and distribute data over the network to several addresses at the same time. In the 'Subscriptions' page under 'Configuration' (Fig. 3.11 and Fig. 3.12), the existing subscriptions can be removed or modified and new ones can be added. Simultaneous subscriptions are possible.







	Address	Data	Format
 	COM2,9600,8,1,NONE	Th0, S0bh, Th0_B4	Default
 	COM2,9600,8,1,NONE	heave, Tm02	Default

Figure 3.11: List of defined subscriptions.

The address for a serial port subscription should have the following format: 'port', 'baud-rate', 'number of data bits', 'number of stop bits', 'parity', 'handshake'. For example the

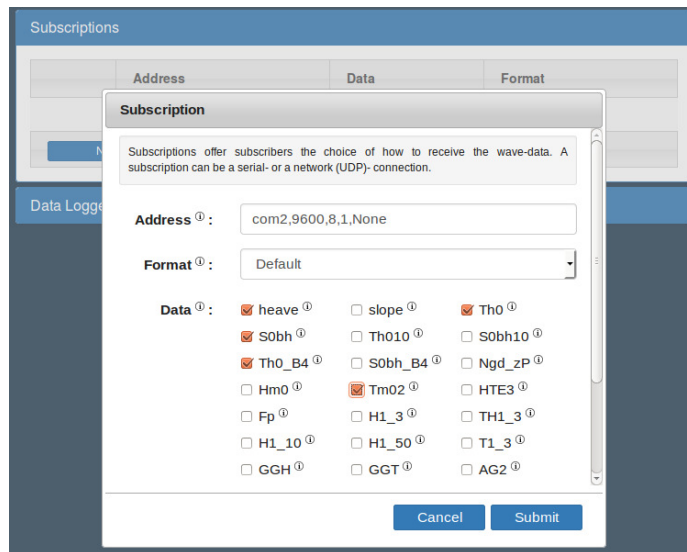

Figure 3.12: Subscriptions dialog.

default values are, COM2,9600,8,1,NONE,NONE.

If the address string is not complete the default values will be used. For example, COM2,9600 will be interpreted as COM2,9600,8,1,NONE,NONE.

The format for the network message is: 'http://ip.address:port'. For example, http://192.168.111.103:8032.

The format of the output string can be chosen from the drop-down menu. Four message format options are available, Default, Format01, Format02 and Format03.

After modifying or creating a new subscription, click the 'update' button and authorize the changes. This will change and store the settings and implement the subscription with immediate effect (no system reboot is required).

### Default message format

The Default format starts a new line for each parameter in the subscription. The time used in the Radac format is Unix Epoch time in milliseconds (UTC time in milliseconds since 00:00:00 on the 1<sup>st</sup> of January 1970). Each line in the Default format ends with a Line-Feed character (char10). When a parameter is disapproved or not available the string 'NaN' is inserted instead of the actual value (NaN stands for Not a Number). An example of the output strings in the Radac format is:

```
time=1157359800206;sensor=radcan;H1=-319.9429cm;
time=1157359259847;sensor=radcan;Hm0=1.2517135cm;
time=1157359860268;sensor=radcan;H1=NaNcm;
```

### Format01 message format

The Format01 message, formerly called the SESAM format, used by the Dutch Ministry of Infrastructure and the Environment (Rijkswaterstaat), is only defined for the heave and the 10 second mean (H parameter). It consists of 8 character lines (Line-Feed character + status character + sign character + 4 character value in cm + Carriage-Return character).

For a regular message the status character is a space. If an error occurs the status character becomes a letter A. An example of the output strings in the RWS format is,

```
+0001  
- 0004  
A+9999
```

### **Format02 message format**

Modifications can be made upon request. For example, the Format02 the Korean Meteorological Administration (KMA format) preferred a readable time format in the Korean time zone. An example of the output strings in the KMA format is:

```
time=2018/01/25 21:55:00;H1=-266.33362cm;  
time=2018/01/25 21:44:00;Hm0=1.2197564cm;  
time=2018/01/25 21:56:00;H1=-266.41037cm;
```

### **Format03 message format**

The Format03 message, formerly called the FGTI format, is used by the Belgium government. Where one string is used for all required information (parameters + spectrum) per processing interval. The chosen parameters are separated by a semicolon (;) and the 51 spectrum values (czz10) are included. The 'NaN' string is replaced with a '-9999' string. An example of the output string in the FGTI format is:

```
time=1516884540000;sensor=wob;Hm0=1.2876906cm;H1/3=1.2812848cm;Czz10=0.0,0.008055651,  
0.15104732,0.6101805,1.962359,2.8207693,0.8498019,0.96278685,0.4353935,0.38063055,0.31748414,0.21270145,  
0.25863284,0.26053977,0.26529723,0.19834366,0.15177727,0.09071115,0.13891238,0.104441345,0.06950364,  
0.037893698,0.030477475,0.02820262,0.026440224,0.02899744,0.03170355,0.022246486,0.017086972,0.0123491855,  
0.016110778,0.024528202,0.023665352,0.02149586,0.024116969,0.03430652,0.022677578,0.02265476,0.020909032,  
0.020626063,0.014051248,0.009640818,0.01388686,0.012247883,0.016294856,0.009297267,0.012917394,0.0054248176,  
0.0040464,0.009096763,0.009700729cm2/Hz;
```

## Technical assistance

The Technical Assistance section on the 'Status' page, provides useful functionalities

The 'Diagnostics' button will cause the system to generate a file containing information about the system settings, status and performance. Please note that it can take up to 3 minutes to generate and download the diagnostics file and that it can contain up to 100 [kB] of data. It is recommended to share the diagnostics file with Radac B.V. because it can help with providing future technical support.

The 'System reboot' button, facilitates a remote system reboot. Please allow 5 minutes for the system to startup after a reboot.

The 'Reset to default' button, allows the user to remotely reset the system to its factory settings. This process is irreversible so please apply caution.

# Chapter 4

## Using the system

### 4.1 Calculated parameters

Once the system is commissioned the facilities of data presentation, reflection diagram, system info etc. can be used to monitor the proper operation of the system.

Water level and wave height information are calculated using the measurements of one radar (the heave source). For directional information the measurements of all three radars are analysed and the directional parameters are calculated. There are two analysis routines:

#### **Wave analysis**

The Standard Wave Processing Package (SWAP) is used in performing time and frequency domain analysis on the measured data to calculate wave parameters. This package is the standard processing package used by the Dutch government for wave height analysis. It also meets the standards set by the International Association of Oil & Gas Producers (OGP). A detailed description of the SWAP package is available on the Radac website (<http://www.radac.nl>).

The SWAP parameters are calculated every minute using 20 minute data blocks. The 20 minute observation block is chosen as a compromise between short enough to obtain "small" variance in the statistical parameters and long enough to assume it to be a stationary process. The time stamp used on SWAP parameters is the mean between the start and end time of the 20 minute data block.

#### **Tide analysis**

The tide parameters H10, H5 and H1 are calculated by averaging measured data over 10 [min], 5 [min] and 1 [min] periods respectively.

Each parameter receives a time stamp central to the block of data that was used for its calculation. The spectra and parameters that can be calculated by the WaveGuide system are described in Appendix 1. Due to the large number of parameters, only a selection of the most commonly used ones is displayed on the user interface. This selection can be modified by Radac upon request.

### 4.2 Data logging

A USB storage device can be easily mounted to the WaveGuide processing unit for data logging. It needs to be said that without taking additional precautions, USB storage is not a safe method for archiving data. Since power failures can damage USB devices, it is advised to use an Uninterrupted Power Supply (UPS) together with a high quality USB device. Having said this, USB storage provides a good backup option while sending data out over a serial or network connection.

The WaveGuide processing unit supports FAT32 , Ext2 and Ext3 formats. The majority of USB devices are delivered with FAT32 format.

**Note**

The USB device used must not be formatted using NTFS.

A USB drive must be manually mounted when first used, and will be automatically re-mounted after a system reboot. Mounting a USB drive can be done via the push buttons on the front panel of the WaveGuide processing unit. Use the right arrow button to scroll to the storage menu. If the message 'Disk not mounted' is displayed, click the down button. If the message 'Mount USB disk? OK' is displayed, click OK to mount the device.

To unmount or remove the disk safely, use the right arrow button to scroll to the storage menu. Then click the down button to arrive at the "Safely remove? OK" option. Clicking the OK button safely unmounts the device.

The 'Data Logger' page in the web user interface (Fig. 4.1) gives access to the stored data. Individual files or complete folders can easily be downloaded using the download button. Additionally the data can be transferred easily to other computers using an FTP application. Both login name and password for FTP file transfers are by default set to 'radac'. The port number is set to 21.

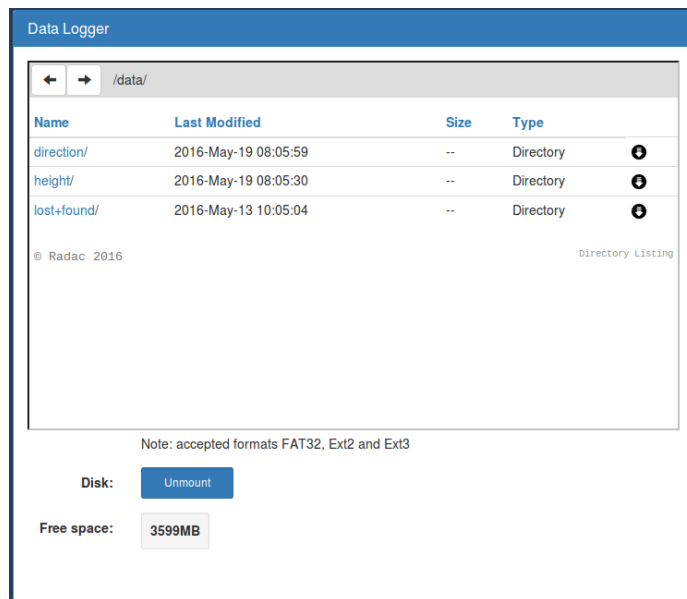

Figure 4.1: Data logger page.

The folder structure used is one directory per system. In this directory, sub-directories are created that contain the raw data and parameter files (one file per day per parameter).

If the drive is full, a delete mechanism starts. This allows the system to store the most recent parameters at the expense of the oldest data.



# Appendix 1: System parameters

## Available parameters

The web user interface presents the raw and processed parameters to the user through the Dashboard page. Tables 1 to 10, describe all the parameters that are measured and calculated by the WaveGuide direction system. Unless stated otherwise, all processed parameters are calculated once per minute and are based on the most recent 20 minutes of data.

Name	Description	Unit
heave	Instantaneous water level (10 Hz)	<i>cm</i>
slopeX	Instantaneous water slope in x-direction (1.28 Hz)	–
slopeY	Instantaneous water slope in y-direction (1.28 Hz)	–
heaveAVG	Instantaneous water lever averaged over all three radars (1.28 Hz)	<i>cm</i>

Table 1: Raw data

Name	Description	Unit
Czz5	Energy density spectrum from 0 to 500 [mHz] in steps of 5 [mHz] (101 values)	<i>cm<sup>2</sup>/Hz</i>
Czz10	Energy density spectrum from 0 to 500 [mHz] in steps of 10 [mHz] (51 values)	<i>cm<sup>2</sup>/Hz</i>
WTBH	Table of wave heights	<i>cm</i>
WTBT	Table of wave periods	<i>s</i>

Table 2: Spectra and wave tables

Name	Description	Unit
Hm0	Significant wave height from M0	<i>cm</i>
M0	Band energy from Czz10(f) in the range $f = [30-500]$ mHz	<i>cm<sup>2</sup></i>
M0_M	Band energy from Czz10(f) in the range $f = [30-1000]$ mHz	<i>cm<sup>2</sup></i>
Hm0_M	Significant wave height from M0_M	<i>cm</i>
Tm02	Average period from M0 and M2 in the range $f = [30-500]$ mHz	<i>s</i>
Tm02_M	Average period from M0 and M2 in the range $f = [30-1000]$ mHz	<i>s</i>
TE0	Band energy from Czz10(f) in the range $f = [500-1000]$ mHz	<i>cm<sup>2</sup></i>
TE1	Band energy from Czz10(f) in the range $f = [200-500]$ mHz	<i>cm<sup>2</sup></i>
TE1_M	Band energy from Czz10(f) in the range $f = [200-1000]$ mHz	<i>cm<sup>2</sup></i>
TE2	Band energy from Czz10(f) in the range $f = [100-200]$ mHz	<i>cm<sup>2</sup></i>
HTE3	Wave height from TE3 (Band energy from Czz10(f) where $f = [30-100]$ mHz)	<i>cm</i>
Fp	Frequency $f$ where Czz10(f) has its maximum in the range $f = [30-500]$ mHz	<i>mHz</i>
Fp_M	Frequency $f$ where Czz10(f) has its maximum in the range $f = [30-1000]$ mHz	<i>mHz</i>
AV10_H	Number of degrees of freedom in the energy density spectrum ( $4 * Ndlr\_H$ )	–
HS7	Wave height from band energy from Czz5(f) in the range $f = [30-142.5]$ mHz	<i>cm</i>
Tm0_1	Minus first moment period from M-1 and M0 in the range $f = [30-500]$ mHz	<i>s</i>
Tm0_1_M	Minus first moment period from M-1 and M0 in the range $f = [30-1000]$ mHz	<i>s</i>

Table 3: Spectral processing parameters

Name	Description	Unit
H1/3	Average height of the highest 1/3 of the waves	<i>cm</i>
TH1/3	Average period of the highest 1/3 of the waves	<i>s</i>
H1/10	Average height of the highest 1/10 of the waves	<i>cm</i>
H1/50	Average height of the highest 1/50 of the waves	<i>cm</i>
T1/3	Average period of the longest 1/3 of the periods	<i>s</i>
GGH	Average height of all waves	<i>cm</i>
GGT	Average period of all waves	<i>s</i>
AG2	Number of waves	–
SPGH	Standard deviation of the wave height	<i>cm</i>
SPGT	Standard deviation of the wave period	<i>s</i>
Hmax	Height of highest wave	<i>cm</i>
Tmax	Period of longest wave	<i>s</i>
THmax	Period of highest wave	<i>s</i>
HCM	Crest height, maximum positive value of all data within one analysis period	<i>cm</i>

Table 4: Time domain parameters.

Name	Description	Unit
Nwt_zP	Sum of periods of waves divided by analysis period	–
Ndlr_H	Number of valid sub-series of the signal in the vertical direction	–
Ngd_zP	Percentage of data-points that do not contain error code before preprocessing	–
Nu_z	Number of valid data-points that are rejected because of 0-sigma errors	–
Nv_z	number of valid data-points that are rejected because of 4-sigma errors	–
Nd_z	number of valid data-points that are rejected because of 4-delta errors	–
Ni_z	number of interpolated or extrapolated vertical wave motion data points	–

Table 5: Quality parameters.

Name	Description	Data-rate [sec]	Unit
H	Average height over last 10 seconds	10	<i>cm</i>
H1	Average height over last 1 minute	60	<i>cm</i>
H5	Average height over last 5 minutes	60	<i>cm</i>
H10	Average height over last 10 minutes	60	<i>cm</i>

Table 6: Water level parameters

Name	Description	Unit
Th010	10 mHz spectrum of mean direction	<i>deg</i>
S0bh10	10 mHz spectrum of directional spreading	<i>deg</i>

Table 7: Directional spectra

Name	Description	Unit
Th0	Average mean direction in the frequency band 30-500mHz	<i>deg</i>
S0bh	Average directional spreading in the frequency band 30-500mHz	<i>deg</i>

Table 8: Directional parameters

In the directional spectral analysis the frequency range from 30-500mHz is divided in separate frequency bands. These frequency bands are given in the Table 9.

Name	Description	Unit
B1	200-500	<i>mHz</i>
B2	100-200	<i>mHz</i>
B3	30-100	<i>mHz</i>
B4	Peak frequency band ( $f_{max}-\Delta f$ to $f_{max}+\Delta f$ )	<i>mHz</i>

Table 9: Frequency bands from 5 [mHz] spectra

Per frequency band 2 parameters are calculated. These parameters are given in Table 10.

Name	Description	Unit
Th0_	Mean direction of the directional distribution in the frequency band	<i>deg</i>
S0bh_	Average width of the directional distribution in the frequency band	<i>deg</i>

Table 10: Parameters in each of the frequency bands

# Appendix 2: System specifications

## WaveGuide radar

### Mechanical

Weight 18.5 [kg] (per sensor incl. antenna 2.8 [kg])  
 Casing material Chromatized aluminium

### Electrical

Radar frequency 9.319 – 9.831 [GHz]  
 Modulation Triangular FMCW  
 Emission The emitted microwave energy is far below acceptable limits for exposure of the human body. Depending on the type of antenna, a maximum radiation of 0.1 [mW] is generated.  
 Power requirements 24-65 [VDC] and 8 [Watt] or 65-240 [VAC] and 8 [Watt]  
 Processor ARM Cortex™A9 792MHz  
 Connectivity Ethernet  
 Memory On board backup memory

### Environmental conditions

Ambient temperature -40 to 65 [°C]  
 Relative humidity 0 – 100 %  
 Ingress protection IP67

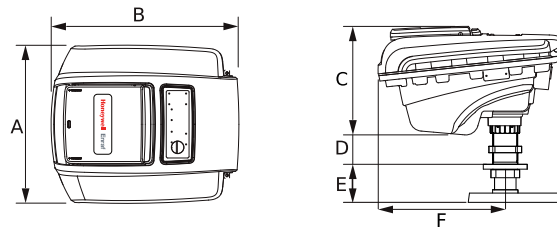

	mm	inches
A	300	11.82
B	330	12.99
C	220	8.66
D	70	2.76
E	60	2.36
F	260	10.24

Figure 1: WaveGuide Explosion Proof dimentions.

## WaveGuide processing unit

Dimensions	170 x 172 x 85 [mm] (depth x width x height) 19" rack mounting available on request
Processor	ARM Cortex™A9 792MHz
Serial data export	2 x RS232 (COM1 and COM2)
Network data export	3 x Ethernet port for configuration, data viewing and data export
Power requirements	24-48 [VDC], 4.8 [Watt]
Operating temperature	-20 to 65 [°C]
Cooling	No fan required
Display	2 x 20 characters
Memory	On board flash
Non functional	3 x RS485 serial port

## General system specifications

Sampling rate	10 [Hz]
Wave heights	0 – 60 [m]
Wave periods	0 – 100 [sec]
Water level accuracy	< 1 [cm]
Processing period:	
wave height	20 [min] (SWAP standard)
wave direction	20 [min] (SWAP standard)
tide	10 [sec], 1, 5 and 10 [min]
processing interval:	
wave height	moving window, all parameters refreshed every 1 minute
wave direction	moving window, all parameters refreshed every 1 minute
tide	moving window, all parameters refreshed every 1 minute

# Appendix 3: LED blinking modes

The WaveGuide sensor is equipped with a blue indicator LED inside the top lid. The purpose of this LED is twofold:

- The LED functions as a status indicator when in standard operating mode. This is the status mode of the LED.
- The LED provides visual assistance when the 2 contacts are connected. This is the settings mode of the LED.

## Settings mode

When a connection is made between the 2 contacts labeled 'reset' the LED will start blinking rapidly at 10 Hz. Depending on when the connection is broken again, the following will happen:

- If the connection lasts between 0.5 and 2 seconds, the ip address is set to the default of 192.168.111.71.
- If the connection lasts between 2 and 10 seconds, nothing happens. During this phase the LED stops blinking. After 10 seconds the LED starts blinking again.
- If the connection lasts more than 10 seconds, the system will be reset to the factory settings, ip address NOT included. However, the system will also receive the default ip address (192.168.111.71) as its second ip address.

After the settings mode is exited the LED will switch to the status mode again.

## Status mode

During operational mode the LED indicates the status of the device by blinking a number of times. The blinking signal consists of a certain number of flashes at 0.5 seconds interval followed by a downtime of 4 seconds. The signal is then repeated. The status of the system determines the number of flashes within the signal.

Table 11 describes the LED's indicator functions.





Indicator pattern		Definition	Remark
Off		No power connected.	–
Solid on		Power is connected and the system is starting.	Wait for 2 minutes, after which the indicator should change its behavior.
Blink 1 time		The system is up and running, but no network is detected.	Check the network cable connections.
Blink 2 times		The system is working normally.	This is the default mode.
Blink 3 times		The ip address was set to the default 192.168.111.71.	Check chapter 3 on how to connect to the sensor.
Blink 3 times		The system was reverted to the factory defaults. Also the default ip address 192.168.111.71 was set.	On release of the reset contact the system will be restarted.

Table 11: Blinking modes